

\*\* THIS IS YOUR SPARE PARTS LIST. SAVE FOR FUTURE REFERENCE, ORDER BY PART NUMBER. CURRENT PRICES WILL BE QUOTED.\*\*

## SPARE PARTS LIST

QTY	ITEM	DESCRIPTION	ASS'Y/PART #
1	1	CYLINDER ASSEMBLY	530-120A
1	2	SIDE FRAME LH	550-014M
1	3	SIDE FRAME RH	550-015M
3	4	FRAME SPACER	530-021M
1	5	TRUNION	550-209M
2	6	CAM BLOCK	530-030M
1	7	CAM PIN	530-029M
1	8	PIVOT PIN	530-026M
2	9	RETAINING RING	1125F
1	10	CLEVIS PIN	150-012M
1	11	RETAINING RING	1039F
6	12	#4-40 x 1/4 PPHMS	1047F
1	13	#6-32 x 3/8 SHCS	1148F
1	14	STEERING BEARING	530-032M
1	15	STEERING ARM ASSEMBLY	530-125A
1	16	STEERING SHAFT (AXLE)	650-010M
1	17	#8-32 KCPSS	1198F
1	18	CENTERING SPRING	550-230M
1	19	#4-40 x 3/16 BHCS	1022F
1	20	#4 FLAT WASHER	1102F

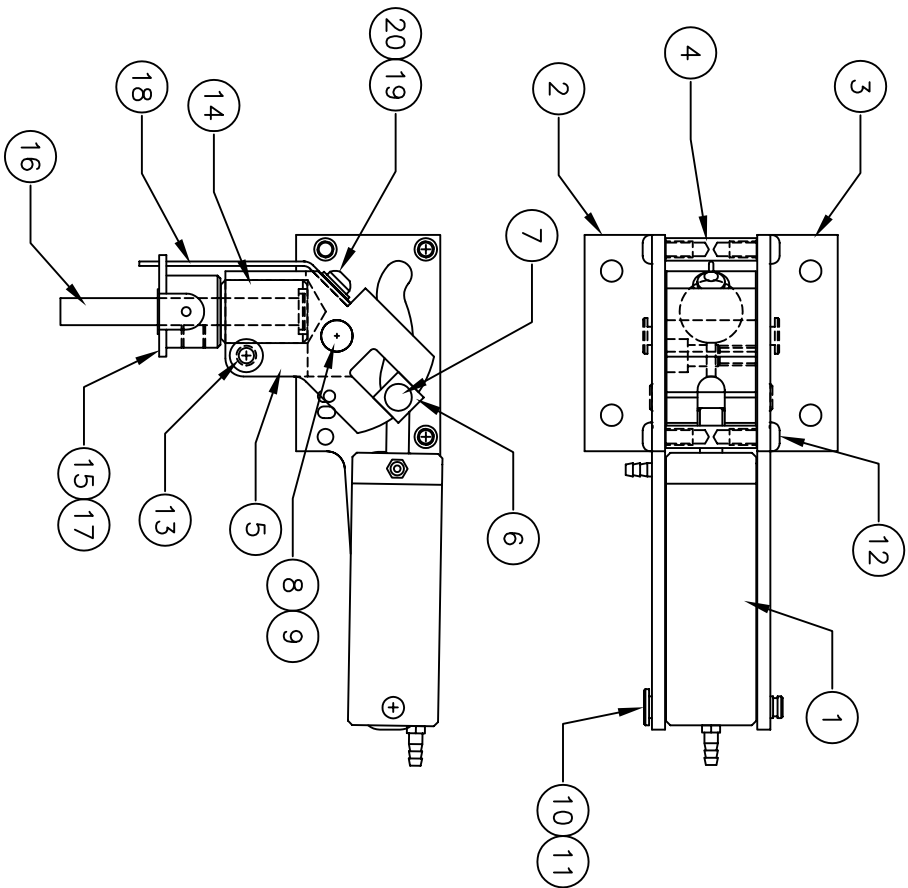

906-198M

FACTORY REPAIR FEE= \$25.00 PLUS PARTS

CHK'D BY		MFG. INC.
DRAWN BY	J. REHAK	625 N. 12TH ST.
DATE	6/03	ST. CHARLES, IL
MODEL No.	555RS	(630)584-7616
TITLE		www.robart.com
SERIES 550 90 DEG.		
NOSE RETRACT ASSEMBLY		
MAIN STYLE FRAMES		