

REVISIONS			
REV.	DESCRIPTION	DATE	APPROVED

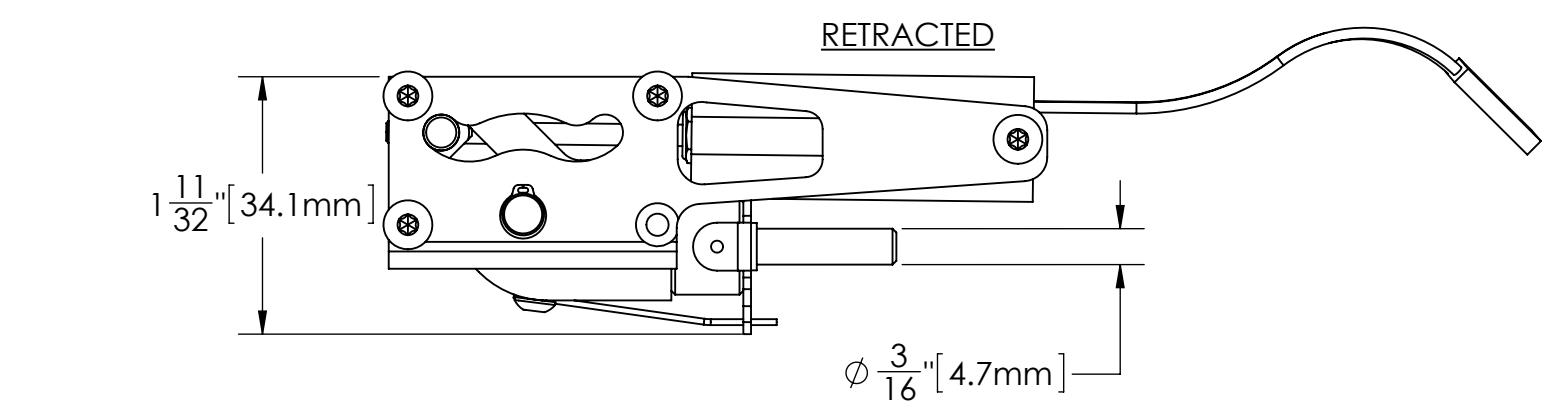
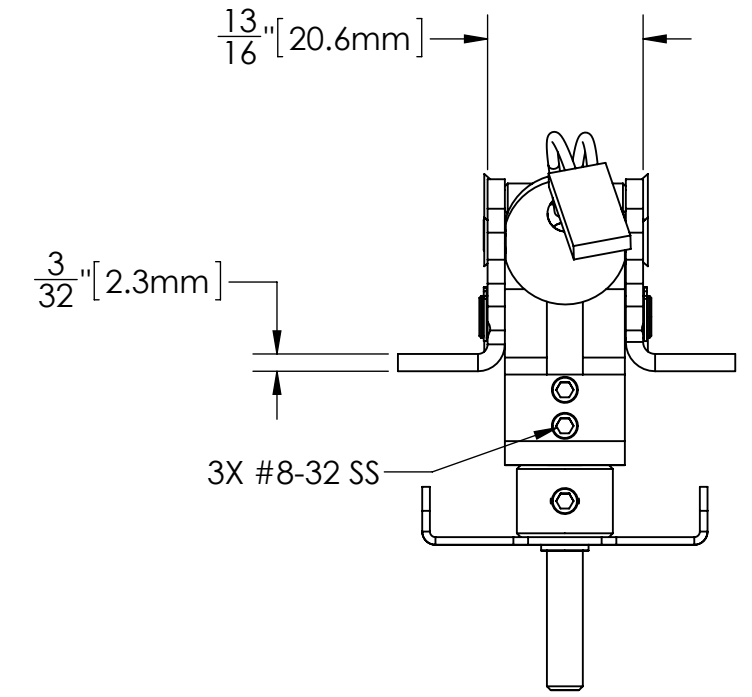
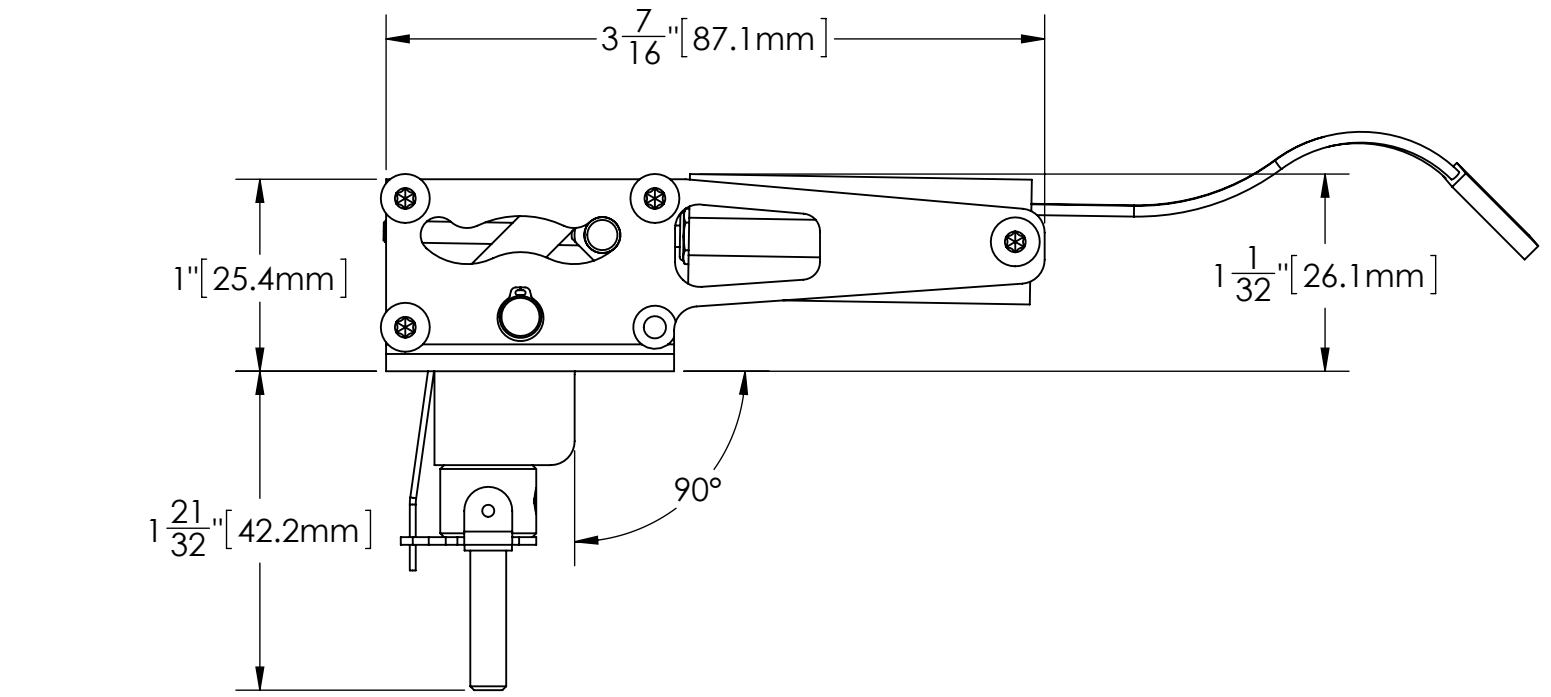
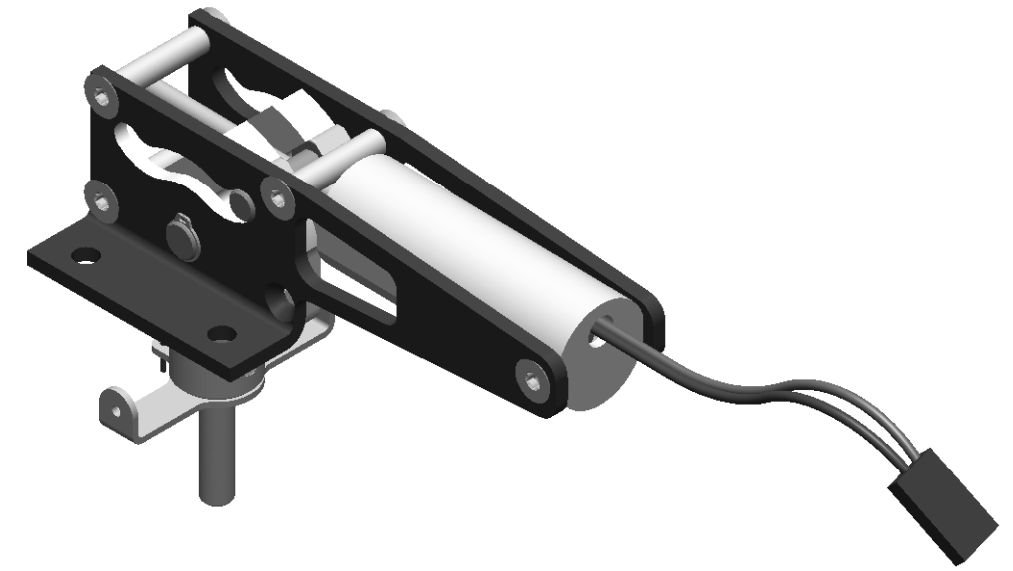
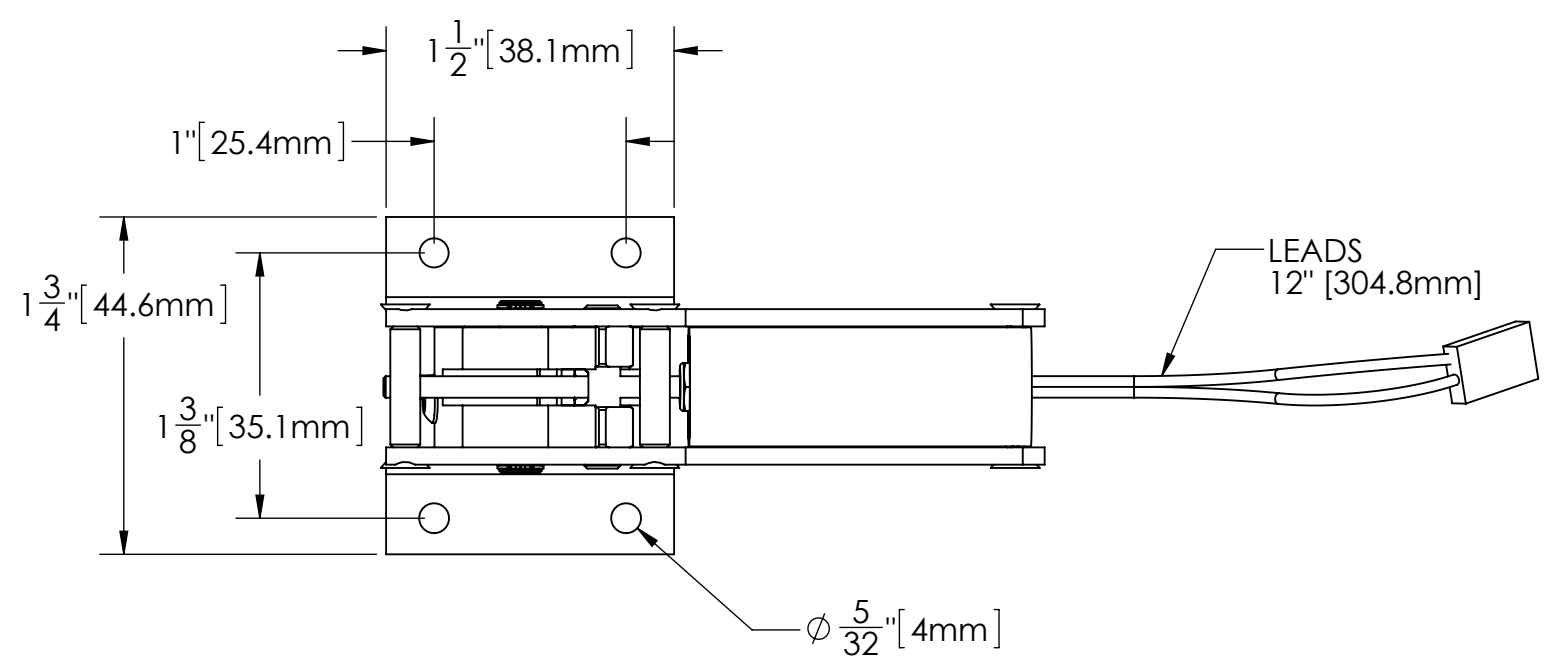

UNITS:
INCH [mm]

ROBART MFG.		
TITLE: DIMENSIONAL DETAIL 555RSE		
SIZE B	DWG. NO. 555RSEDIM	REV -
SCALE: 1:1	WEIGHT:	SHEET 1 OF 1

PROPRIETARY AND CONFIDENTIAL THE INFORMATION CONTAINED IN THIS DRAWING IS THE SOLE PROPERTY OF ROBART MANUFACTURING. ANY REPRODUCTION IN PART OR AS A WHOLE WITHOUT THE WRITTEN PERMISSION OF ROBART MANUFACTURING IS PROHIBITED.	UNLESS OTHERWISE SPECIFIED: DIMENSIONS ARE IN INCHES TOLERANCES: FRACTIONAL ± 1/32 ANGULAR: MACH ± 1° BEND ± 1° TWO PLACE DECIMAL ± 0.01 THREE PLACE DECIMAL ± 0.005 FOUR PLACE DECIMAL ± 0.0005	DRAWN	N.MARC	DATE	22JUL14
	CHECKED				
	MFG APPR.				
	Q.A.				